









# KE 24-IN. PUB HEIGHT SQUARE GLASS TABLE

## Assembly Instructions

- ✧ **WARNING!** Adult assembly required. Please keep screws and parts out of reach of children.
- ✧ Wait to fully tighten the fasteners until all have been inserted and hand tightened.
- ✧ Do not sit or stand on the table as it may cause injury.
- ✧ **To completely stabilize umbrella, an umbrella base must always be used. Table cannot independently support umbrella.**

No.	Sketch	QTY
A		4
B		1
C		1
D		1
E		20
F		8
G	 M6x15mm	4
H	 M6x53mm	8
J		2

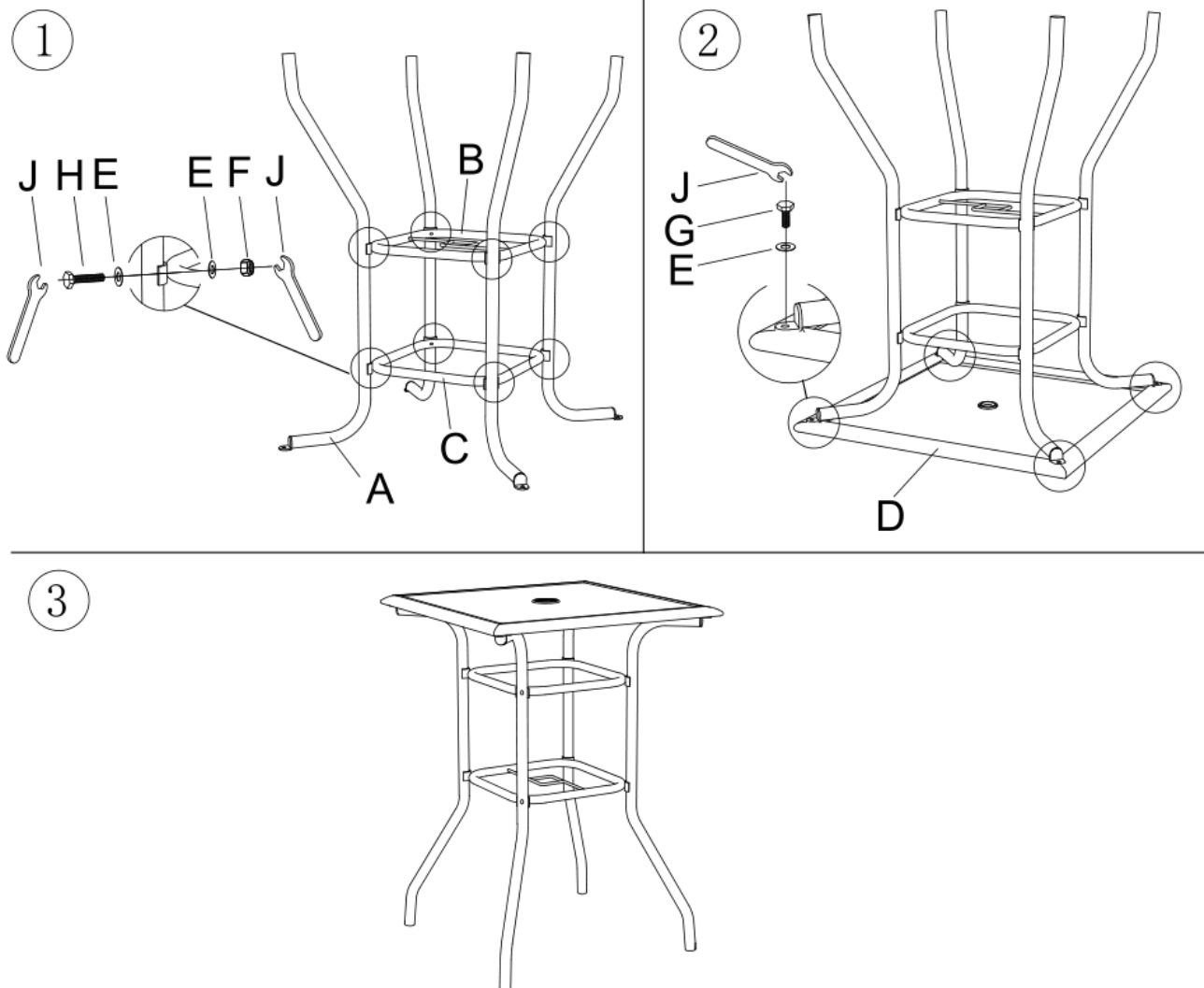



## Care & Maintenance

Wear and tear including but not limited to rust, paint chips and scratches on your patio furniture set is not covered in the warranty. As such, please note the below:

Your table is made from durable Powder Coated Steel frames that will need maintenance to keep looking great and functioning well. In order to best manage natural wear and tear, we highly recommend covering your patio furniture when not in use and especially during inclement weather. Patio furniture covers can be purchased at many retailers and on the Internet.

If your furniture remains in inclement weather, we recommend inspecting for signs of rust. If rust is dripping from your table, wipe off and rinse the table and surrounding ground area to avoid staining. You may also choose to move your table to separate area to dry off to avoid staining your deck or patio.

Most rust can be treated with the touch up paint provided. You may request from customer service by calling 888-529-6524. You can also apply secondary market rust inhibitor products / paint available at many retail outlets.

## 1 Year Limited Warranty

What is covered: One year warranty on the steel frame structure and welds to the original purchaser from the date of purchase. Should the steel frame fail due to a manufacturing defect, we will repair or replace at our option.

What is not covered: Warranty does not cover damage due to rust, weather, general use or misuse, shattered glass, commercial use, scratches/paint chips, fading paint or anything considered general wear and tear. Freight and handling charges to and from our service center are not covered under warranty. In some cases, photography may be required for service to be rendered.

- Proof of purchase is required for all warranty claims.
- Products not sold in their original packaging, floor models or products sold at markdown not in original condition may be excluded from warranty at our discretion.
- Warranty subject to change without notification.
- For more information, please visit [www.SarasotaBreezeService.com](http://www.SarasotaBreezeService.com) or email us at [Sarasota@4seasonsglobal.com](mailto:Sarasota@4seasonsglobal.com)
- For parts requests and customer service, please call 1.888.529.6524

Style # TBBG10PR